

4/3 servo directional control valve with mechanical position feedback

RE 29583-XH-100-B2/05.07
Replaces: 10.05

Type 4WS2EM 10...XH...-100

Nominal size 10
Unit series 5X
Maximum operating pressure 315 bar
Maximum flow rate 180 l/min



ATEX units
For potentially explosive atmospheres

Part II Technical Data Sheet



Information on explosion protection:

Range of application in accordance with the
Explosion Protection Directive and type of protection to
EN 50014:1997+A1+A2

- Range of application as per Directive RL 94/9/EG
- **II1G:** Type of protection EEx ia IIC T4 to EN 50020:1994
- Ambient temperature range $-20^{\circ}\text{C} \leq T_a \leq +60^{\circ}\text{C}$

What you need to know about these Operating Instructions

These Operating Instructions apply to the explosion-proof version of Rexroth valves,
and consist of the following three parts:

- Part I General Information RE 07010-X-B1
- Part II Technical Data Sheet RE 29583-XH-100-B2
- Part III Product-specific Instructions RE 29583-XH-100-B3

Mat.-No. R901096785

You can find further information on the correct handling of Rexroth hydraulic products in our publication
"General Product Information for Hydraulic Products", RE 07008.

Overview of Contents

Contents	Page
Features	2
Ordering data and scope of delivery	3
Symbol	3
Function, sectional diagram	4
Technical data	5 and 6
Information on explosion protection	6
External trigger electronics	6
Plug-in connector	7
Electrical connection	7
Characteristic curves	8 to 11
Unit dimensions	12
Flushing plate	13

Features

- Servo directional control valve for proper use in potentially explosive atmospheres of Zones 0
- Valve for closed-loop position, draft, pressure and velocity control
- 2-Stage servo valve in 3-way version with mechanical feedback
- 1st stage in the form of flapper nozzle amplifier
- For subplate mounting,
Mounting hole configuration to ISO 4401-05-05-0-05 with ports X and Y.
Subplates as per Technical Data Sheet RE 45054 (order separately)
- Dry servo motor, no contamination of solenoid gaps by pressure fluid
- Non-wearing piston return element
- Actuation:
External trigger electronics in Eurocard format or in modular form (order separately), see page 6
- Valve is calibrated and tested
- Internal/external control oil supply and return individually orderable
- Piston with flow force compensation
- Control sleeve permanently centered, therefore reducing sensitivity to temperature and pressure
- Pressure chambers in the control bush have gap seals, so there is no O-ring wear
- Filter for 1st stage freely accessible from the outside

Ordering data and scope of delivery

4WS2E	M	10-5X/	B	11	XH	K31	V-100
Electrically operated 2-stage servo valve, 4/3-way version for external trigger electronics		Mechanical feedback = M		Nominal size 10 = 10		Unit series 50 to 59 (50 to 59: installation and connection dimensions unchanged) = 5X	
Nominal flow ¹⁾							
5 l/min = 5		10 l/min = 10		20 l/min = 20		30 l/min = 30	
45 l/min = 45		60 l/min = 60		75 l/min = 75		90 l/min = 90	
Valve for external trigger electronics		Coil No. 11 (30 mA/85 Ω per coil) ²⁾				= 11	
Included in scope of delivery:							
– Ventilbefestigungsschrauben							
– Valve operating instructions with Declaration of Conformity in Part III							
100 = Non-standard version number ⁶⁾ Seal material V = FKM seals suitable for mineral oil (HL, HLP) to DIN 51524 Piston overlap ⁵⁾ E = 0 ... 0,5 % negative D = 0 ... 0,5 % positive C = 3 ... 5 % positive Electrical connection K31 = with plug to EN175201-804 Plug-in connector – order separately see Page 7 Supply pressure range to 1st stage ⁴⁾ 210 = 10 to 210 bar 315 = 10 to 315 bar Control oil supply and discharge ³⁾ - = External supply, external return E = Internal supply, external return T = External supply, internal return ET = Internals supply, internal return (ET = Standard version) XH = Valve in explosion-proof design For details, see information on explosion protection, page 6							

1) Nominal flow rate

The nominal flow rate is based on a 100 % setpoint signal at a valve pressure differential of 70 bar (35 bar per metering notch). The valve pressure differential should be regarded as a guide. The flow rate can be affected by other values. A possible nominal flow tolerance of ±10 % (see flow signal function on page 8) must be taken into consideration.

2) External trigger electronics

The control signal must be generated by a current-regulated output stage with superimposed dither signal. For trigger electronics (servo amplifiers), see page 6.

3) Control oil

The pilot pressure should be kept as constant as possible. Therefore, external pilot control via port X can be advantageous. The valve may be operated with higher pressure at X than at P, to increase the dynamics.

Note:

Ports X and Y are also subject to pressure when the supply and return of control oil are "internal".

4) Supply pressure range

The system pressure should be kept as constant as possible. Pilot pressure range: 10 ... 210 bar or 10 ... 315 bar. With regard to the dynamics, the dependence on the frequency response must be taken into account within the permitted pressure range.

5) Piston overlap

The piston overlap is stated in % of the control piston stroke.

6) Non-standard version number "100"

When not actuated (power off), ducts P → B and A → T are open 10 % of the nominal volume.

Symbol

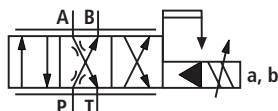

Function, sectional diagram

4WS2EM 10...XH...-100

Valves of this type are electrically operated, 2-stage servo directional control valves with a mounting hole configuration to ISO 4401-05-05-0-05. They are predominantly employed for closed-loop position, draft, pressure and velocity control.

These valves consist of an electro-mechanical governor (torque motor) (1), a hydraulic amplifier (flapper jet principle) (2) and a control piston (3) in a sleeve (2nd stage), which is connected to the torque motor via a mechanical return.

An electric input signal at the coils (4) of the torque motor causes a permanent magnet to generate a force that acts on the armature (5) and, acting by means of a torque tube (6), this force generates a torque. This torque then moves the flapper plate (7) which is connected to the torque tube (6) by a rod out of its center position between the two control orifices (8), resulting in a pressure differential at the end faces of the control piston (3). This pressure differential causes the position of the piston to change, so that the pressure port is connected to one consumer port and, at the same time, the other consumer port is connected to the return port.

The control piston is connected to the flapper plate or the torque motor by a torsion spring (mechanical return) (9). The position of the piston continues to change until the return torque through the torsion spring and the electro-magnetic torque of the torque motor reach a state of equilibrium, and the pressure differential at the flapper jet system becomes zero.

In this way, the stroke of the control piston and thus the flow of the servo valve is closed loop controlled proportionately to the electrical input signal. At the same time, it should be noted that the flow is dependent on the drop in valve pressure.

External trigger electronics (order separately)

The valve is actuated by external trigger electronics (a servo amplifier), which amplifies an analog input signal (setpoint) so that the controlled current output signal is capable of driving the servo valve.

Type 4WS2EM 10...XH...-100

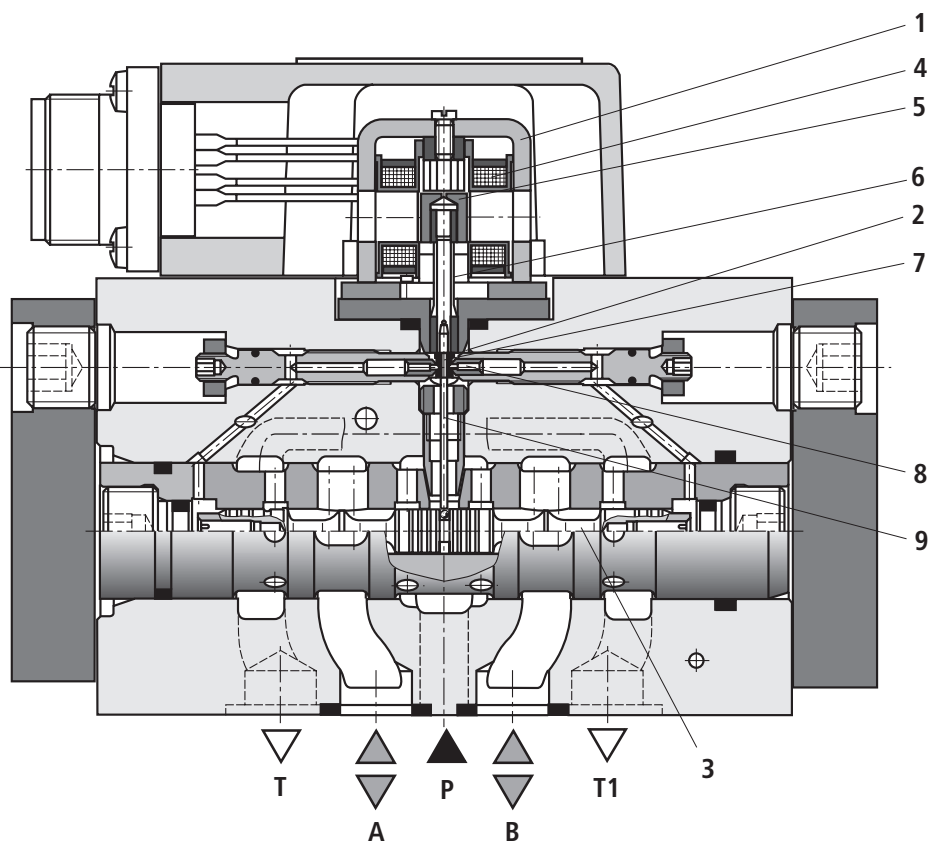

Technical data

General		
Mounting hole configuration		ISO 4401-05-05-0-05
Installation position		Optional (provided that the pilot control is certain to receive sufficient pressure (≥ 10 bar) when starting up the system!)
Surface protection	Valve body, cover, filter screw	Nitrocarburized
	Cap	Anodized
Storage temperature range	°C	-20 ... +70
Ambient temperature range	°C	-20 ... +60
Weight	kg	3.56

Hydraulic (measured with HLP 32, $\vartheta_{oil} = 40$ °C \pm 5 °C)

Working pressure:	Control oil supply pilot stage	bar	10 ... 210 or 10 ... 315							
	Main valve, ports P, A, B	bar	up to 315							
Return pressure:	Port T									
	Internal control oil return	bar	Pressure peaks < 100 permitted							
	External control oil return	bar	up to 315							
	Port Y	bar	Pressure peaks < 100 permitted, static < 10							
Pressure fluid			Mineral oil (HL, HLP) to DIN 51524 ignition temperature > 150 °C							
Pressure fluid temperature range		°C	-15 ... +60, preferably +40 ... +50							
Viscosity range		mm ² /s	15 ... 380, preferably 30 ... 45							
Maximum permissible degree of contamination of pressure fluid Purity class to ISO 4406 (c)			Class 18/16/13 ¹⁾							
Zero flow q_{VL} ²⁾ with piston overlap E measured without dither signal		l/min	$\sqrt{\frac{p_P}{70\text{bar}} \cdot 0.7 \frac{l}{\text{min}}}$	$\sqrt{\frac{p_P}{70\text{bar}} \cdot 0.9 \frac{l}{\text{min}}}$	$\sqrt{\frac{p_P}{70\text{bar}} \cdot 1.2 \frac{l}{\text{min}}}$	$\sqrt{\frac{p_P}{70\text{bar}} \cdot 1.5 \frac{l}{\text{min}}}$	$\sqrt{\frac{p_P}{70\text{bar}} \cdot 1.7 \frac{l}{\text{min}}}$			
Nominal flows $q_{v\text{nom}}$ ³⁾ , Tolerance ± 10 % at valve pressure differential $\Delta p = 70$ bar (35 per edge)		l/min	5	10	20	30	45	60	75	90
Max. possible control piston stroke based on mechanical end position (in case of fault) referred to nominal stroke		%	120 ... 170				120 ... 150			
Return system			Mechanical							
Hysteresis (ditheroptimiert)		%	≤ 1.5							
Range of inversion (dither optimized)		%	≤ 0.2							
Response sensitivity (dither optimized)		%	≤ 0.2							
Pressure gain with 1 % piston stroke variation (starting from hydraulic zero)		% of p_P ⁴⁾	≥ 30							
Zero adjustment flow over entire working pressure range		%	≤ 3 , long-term ≤ 5							
Zero offset on variation of:										
	Pressure fluid temperature	% / 20 K	≤ 1							
	Ambient temperature	% / 20 K	≤ 1							
	Working pressure 80 ... 120 % of p_P ⁴⁾	% / 100 bar	≤ 2							
	Return pressure 0 ... 10 % of p_P ⁴⁾	% / bar	≤ 1							

¹⁾ The purity classes stated for the components must be complied with in hydraulic systems. Effective filtration prevents problems and also extends the service life of components.

For a selection of filters, see Technical Data Sheets RE 50070, RE 50076 and RE 50081.

²⁾ q_{VL} = zero flow in l/min

³⁾ $q_{v\text{nom}}$ = nominal flow in l/min

⁴⁾ p_P = working pressure in bar

Technical data**Electrical**

Degree of protection to EN 60529:1991+A1:2000	IP 65 with correctly mounted and locked plug-in connector	
Type of signal	Analog	
Nominal current per coil	mA	30
Resistance per coil	Ω	85
Inductivity at 60 Hz and 100 % nominal current	Parallel connection	H 0.25
Necessary superimposed dither signal when actuating with non-Rexroth amplifiers: $f = 400$ Hz	Amplitude depending on hydraulic system: max. 3 % of nominal current	

Information on explosion protection

Type test certification ¹⁾	PTB 03 ATEX 2119 X	
Range of application to Directive RL 94/9/EG	II 1 G	
Type of protection to EN 50020:1994	EEx ia IIC T4	
Ambient temperature range	$^{\circ}\text{C}$	-20 ... +60
Pressure fluid temperature range	$^{\circ}\text{C}$	-15 ... +60
Valve is only supplied with power from certified, intrinsically safe circuits with the following maximum values	U_{\max}	V 9,3
	I_{\max}	mA 390
	P_{\max}	mW 907
Conditions for use in Zone 0	The valve cap consists of cast aluminium. When the valve is to be used as a Category 1 device in Zone 0, the valve cap must be protected in such a manner that no ignitable sparks from friction, impact or grinding can be produced, even in the event of rarely occurring malfunctions. Note: The hydraulic fluid used must have an ignition temperature of at least 150°C.	
Required free space for burst protection	The specified free space for burst protection (see Page 12) must remain free, in order that excess pressure occurring in the event of a fault can be dissipated through the plug in the valve cap.	

External trigger electronics

Servo amplifier ²⁾ in modular design	Analog	Type VT 11021 as per Technical Data Sheet RE 29743
Recommended safety barriers ²⁾	Single-channel	Fa. Stahl, Type 9001/02-093-390-101

⚠ WARNING – risk of explosion

– The servo amplifier and safety barriers must be operated outside the potentially explosive atmosphere!

¹⁾ The type approval certificate is not available separately.
In accordance with the ATEX Directive, a Declaration of Conformity will be produced and supplied with the product.

²⁾ Order separately

Plug-in connector

Electrical connection EN 175201-804

Metal version

Order separately under Material No. **R900223890**

Connection:

Soldered contacts with conductor cross-section for wires 0.5 ... 1.5 mm²

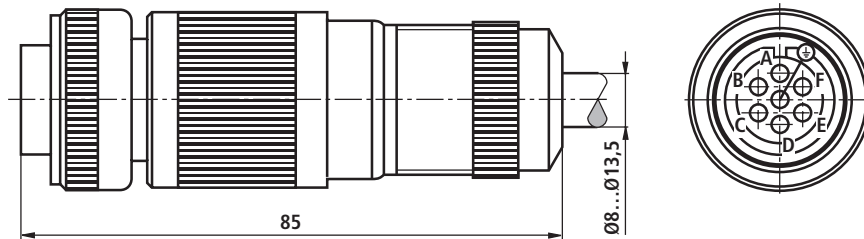

Electrical connection

The coils may only be connected **in parallel**.

Electrical actuation with positive (+) to A and B and negative (-) to C and D results in a flow direction of P → A and B → T.

Inverse electrical actuation produces a flow direction of P → B and A → T.

Pins E, F and PE on the plug are not connected.

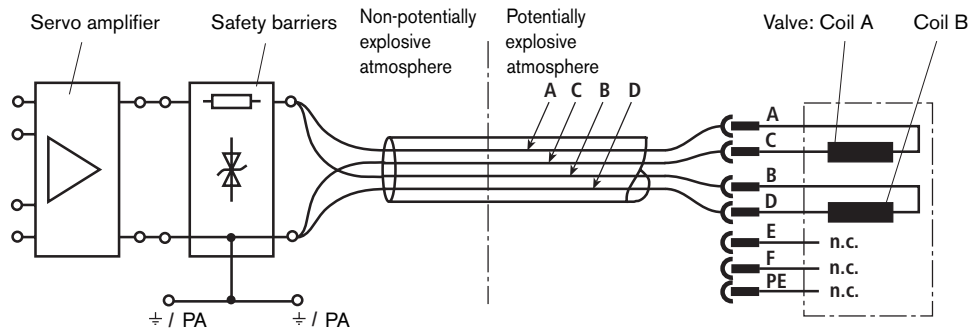

Note

Only approved cables and leads may be used for intrinsically safe circuits.

Characteristic curves (measured with HLP32, $\vartheta_{oil} = 40\text{ °C} \pm 5\text{ °C}$)

Flow load function (tolerance $\pm 10\%$) with 100 % setpoint signal

Note:

Observe flow values in the max. setpoint range (see tolerance zone of flow signal function)

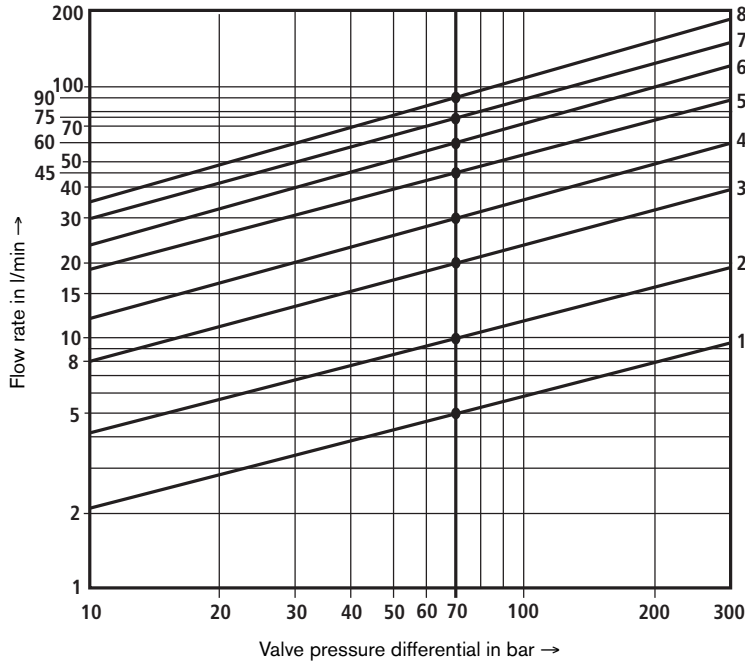

Order code	Nominal flow	Curve
5	5 l/min	1
10	10 l/min	2
20	20 l/min	3
30	30 l/min	4
45	45 l/min	5
60	60 l/min	6
75	75 l/min	7
90	90 l/min	8

Δp = valve pressure differential
(inlet pressure p_p
minus load pressure p_L and
minus return pressure p_r)

Tolerance zone of flow signal function with constant valve pressure differential Δp

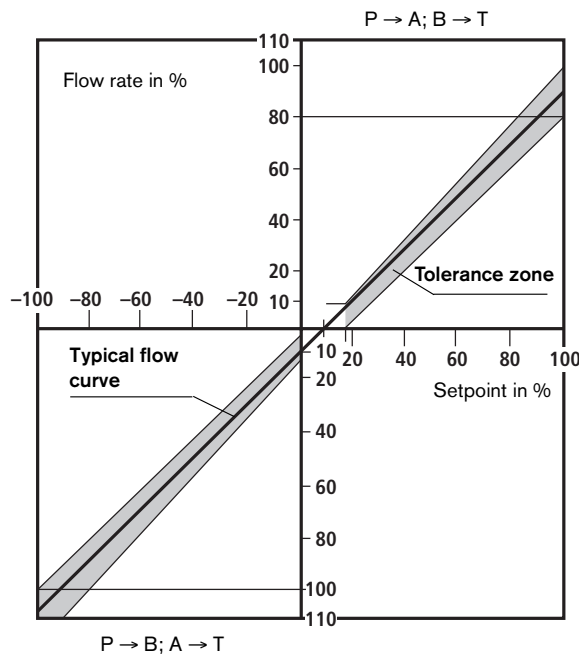

Characteristic curves (measured with HLP 32, $\vartheta_{oil} = 40\text{ °C} \pm 5\text{ °C}$)

Transient function with 315 bar pressure stage, step response without flow (measured with safety barrier ¹⁾)

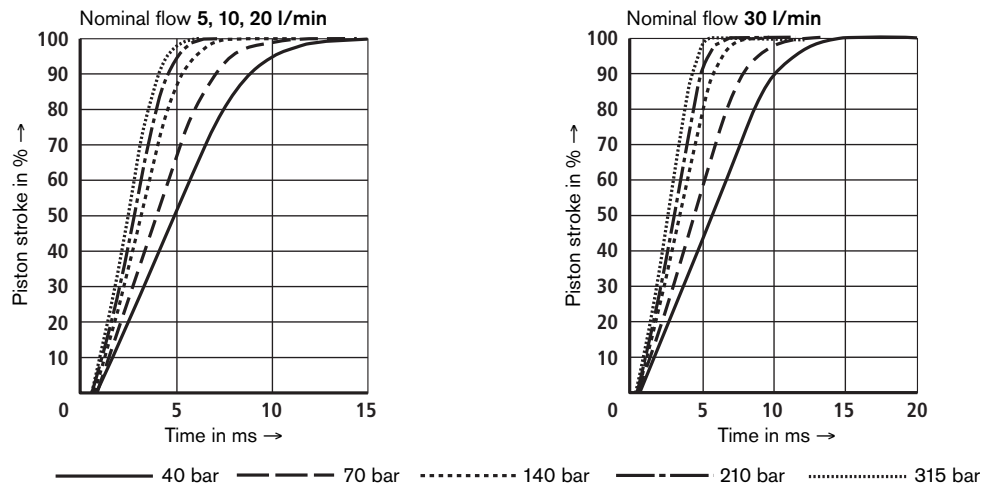

Frequency response with 315 bar pressure stage, stroke frequency response without flow (measured with safety barrier ¹⁾)

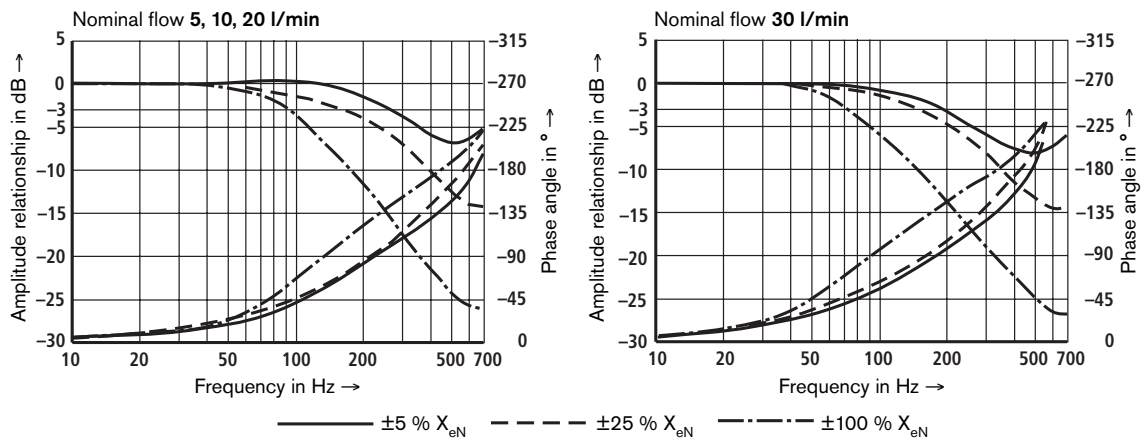

Relationship of frequency f at -90 ° to working pressure p and input amplitude (measured with safety barrier ¹⁾)

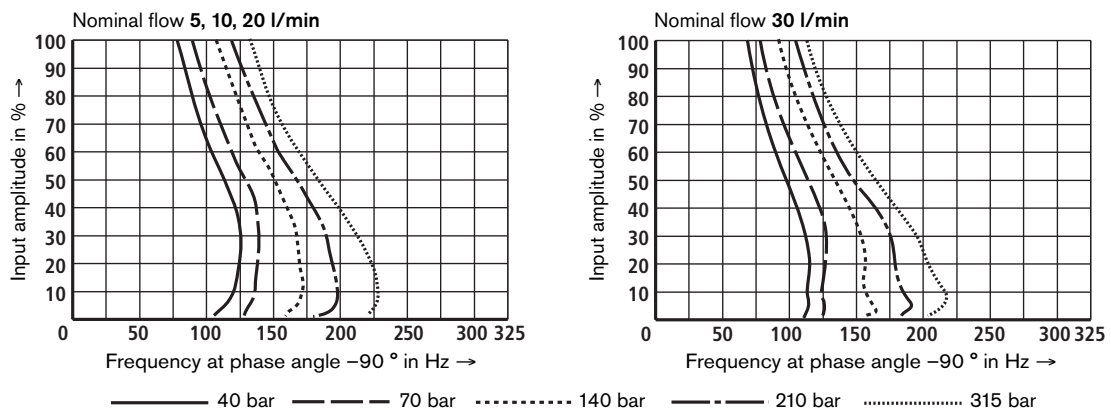

¹⁾ See pages 6 and 7 for information on the safety barrier

Characteristic curves (measured with HLP 32, $\vartheta_{oil} = 40\text{ °C} \pm 5\text{ °C}$)

Transient functions with 315 bar pressure stage, step response without flow (measured with safety barrier ¹⁾)

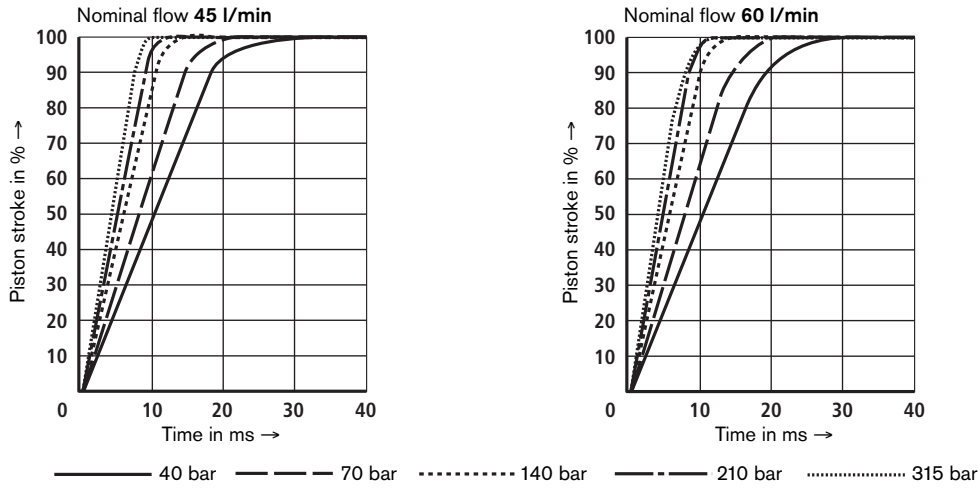

Frequency response with 315 bar pressure stage, stroke frequency response without flow (measured with safety barrier ¹⁾)

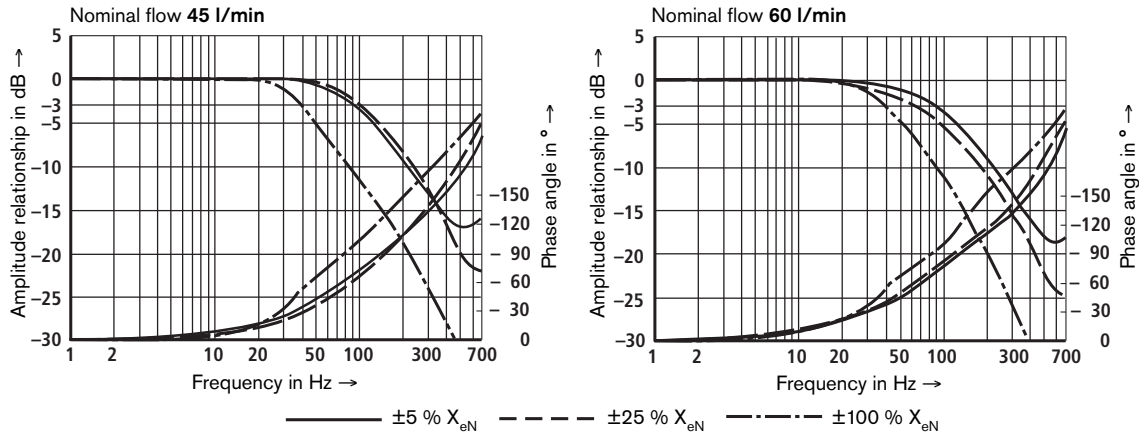

Relationship of frequency f at -90° to working pressure p and input amplitude (measured with safety barrier ¹⁾)

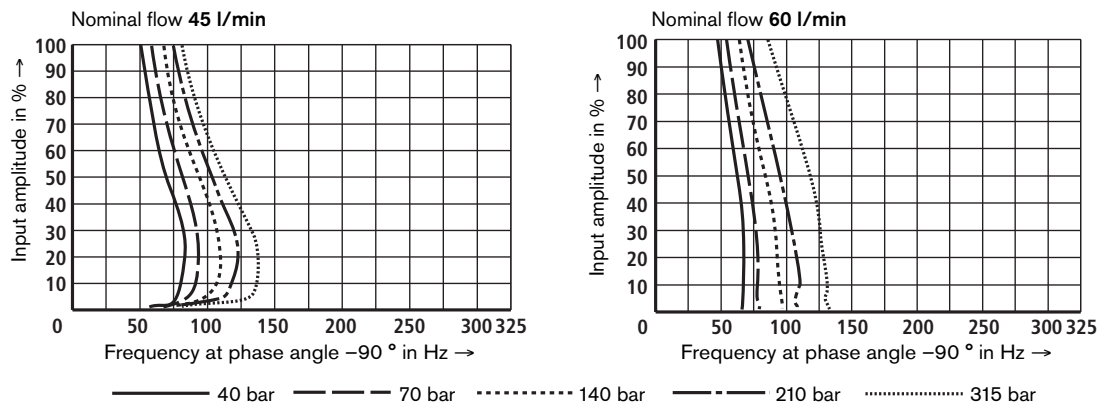

¹⁾ See pages 6 and 7 for information on the safety barrier

Characteristic curves (measured with HLP 32, $\vartheta_{oil} = 40\text{ °C} \pm 5\text{ °C}$)

Transient functions with 315 bar pressure stage, step response without flow (measured with safety barrier ¹⁾)

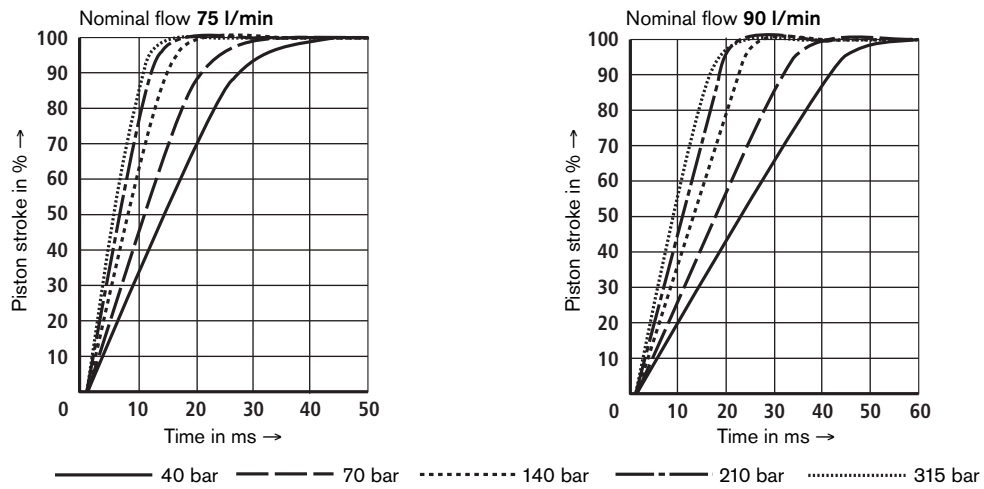

Frequency response with 315 bar pressure stage, stroke frequency response without flow (measured with safety barrier ¹⁾)

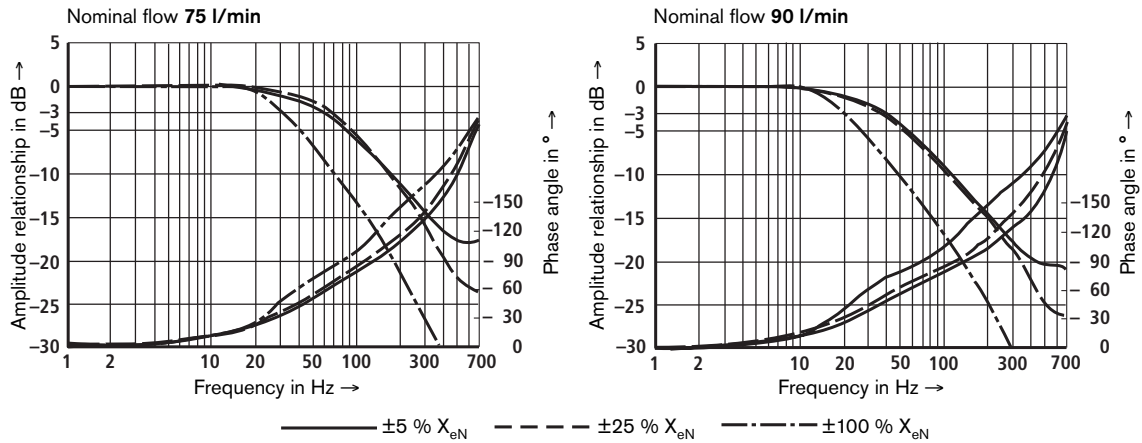

Relationship of frequency f at -90° to working pressure p and input amplitude (measured with safety barrier ¹⁾)

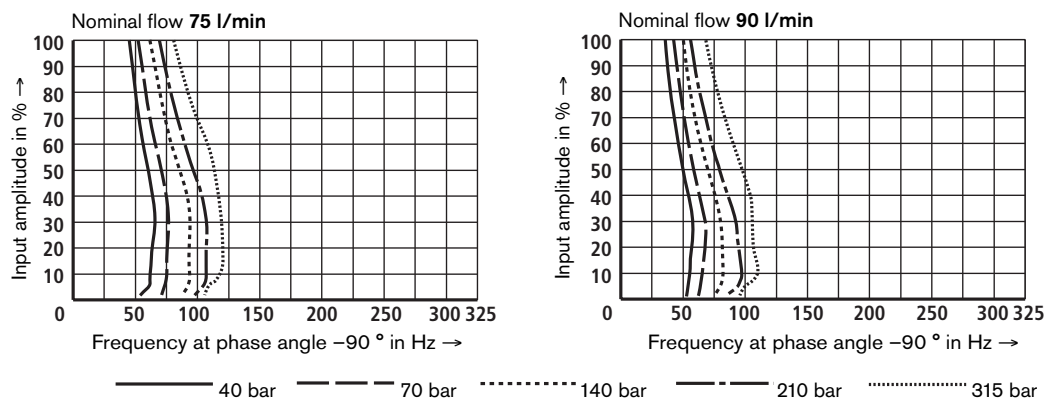

¹⁾ See pages 6 and 7 for information on the safety barrier

Unit dimensions (Nominal dimensions in mm)

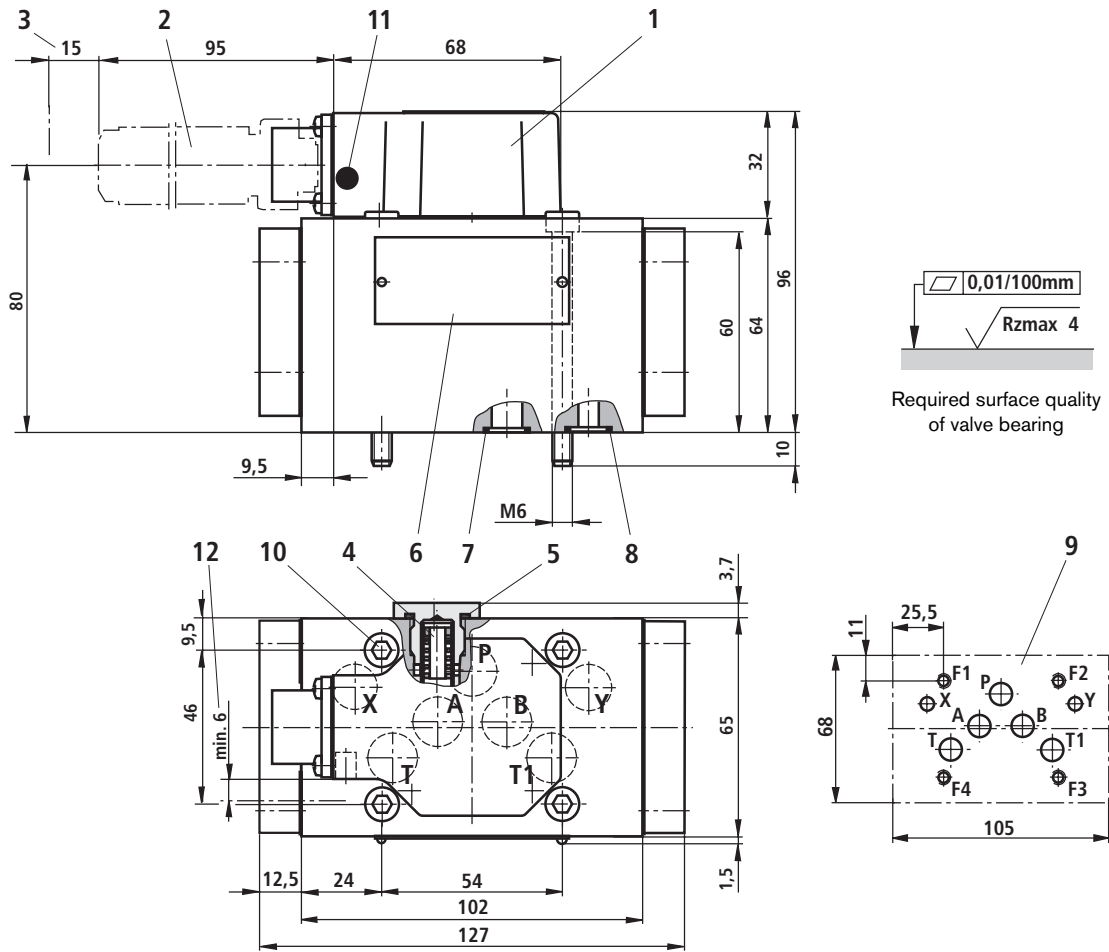

- 1 Cap
- 2 Plug-in connector
(order separately, see Page 7)
- 3 Required space for removing plug-in connector, note additional bending radius of connecting cable
- 4 Replaceable filter element
Material No.: **R900306843**
- 5 Formed gasket for filter screw M16 x 1.5
Material No.: **R900012503** (FKM seal)
- 6 Nameplate
- 7 Same seals for ports P, A, B, T and T1
- 8 Same seals for ports X and Y
Ports X and Y are also pressurized when the control oil supply and return are "internal".
- 9 Machined valve contact surface
Position of ports as per ISO 4401-05-05-0-05
Port T1 is optional and is recommended for reducing the pressure difference from B → T.

- 10 Valve fastening bolts
In order to ensure a secure connection, use only the following valve fastening bolts:
4 cheese-head bolts
ISO 4762-M6x70-10.9-flZn-240h-L
(coefficient of friction 0.09 - 0.14 to VDA 235-101)
(included in scope of delivery)
- 11 Burst protection
- 12 Free space for burst protection

Subplates as per Technical Data Sheet RE 45054 must be ordered separately.

- G 66/01 (G3/8)
- G 67/01 (G1/2)
- with ports X and Y:
- G 535/01 (G3/4)
- G 535/02 (M27 x 2)
- G 536/01 (G1)
- G 536/02 (M33 x 2)

Flushing plate with mounting hole configuration to ISO 4401-05-05-0-05

(Nominal dimensions in mm)

Symbol

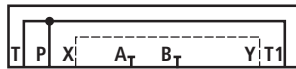

Ordering data and further information

- Material No.: **R900912450**
- Weight: 2 kg
- Same seals for ports P, A, B, T and T1
- Same seals for ports X and Y
- Fastening bolts
In order to ensure a secure connection, use only the following fastening bolts:
4 cheese-head bolts
ISO 4762-M6x50-10.9-flZn-240h-L
(coefficient of friction **0.09 - 0.14** to VDA 235-101)
(included in scope of delivery)

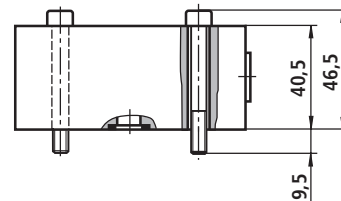

Note

Before assembly, please read the notes in the Product-specific Instructions RE 29583-XH-100-B3, section 3.2.

Notes

Bosch Rexroth AG
Hydraulics
Zum Eisengießer 1
97816 Lohr am Main, Germany
Telefon +49 (0) 93 52 / 18-0
Telefax +49 (0) 93 52 / 18-23 58
documentation@boschrexroth.de
www.boschrexroth.de

© This document, as well as the data, specifications and other information set forth in it, are the exclusive property of Bosch Rexroth AG. It may not be reproduced or given to third parties without its consent.
The data specified above only serve to describe the product. No statements concerning a certain condition or suitability for a certain application can be derived from our information. The information given does not release the user from the obligation of own judgment and verification. It must be remembered that our products are subject to a natural process of wear and aging.

HYQUIP

New Brunswick Street Horwich Bolton BL6 7JB UK
Tel: +44 (0)1204 699959 Fax: +44 (0)1204 699542
Email: enquiries@hyquip.co.uk Web: www.hyquip.co.uk

Notes

Bosch Rexroth AG
Hydraulics
Zum Eisengießer 1
97816 Lohr am Main, Germany
Telefon +49 (0) 93 52 / 18-0
Telefax +49 (0) 93 52 / 18-23 58
documentation@boschrexroth.de
www.boschrexroth.de

© This document, as well as the data, specifications and other information set forth in it, are the exclusive property of Bosch Rexroth AG. It may not be reproduced or given to third parties without its consent.
The data specified above only serve to describe the product. No statements concerning a certain condition or suitability for a certain application can be derived from our information. The information given does not release the user from the obligation of own judgment and verification. It must be remembered that our products are subject to a natural process of wear and aging.

HYQUIP

New Brunswick Street Horwich Bolton BL6 7JB UK
Tel: +44 (0)1204 699959 Fax: +44 (0)1204 699542
Email: enquiries@hyquip.co.uk Web: www.hyquip.co.uk

Notes

© This document, as well as the data, specifications and other information set forth in it, are the exclusive property of Bosch Rexroth AG. It may not be reproduced or given to third parties without its consent.
The data specified above only serve to describe the product. No statements concerning a certain condition or suitability for a certain application can be derived from our information. The information given does not release the user from the obligation of own judgment and verification. It must be remembered that our products are subject to a natural process of wear and aging.